

the  
Quiltfox™  
Creations

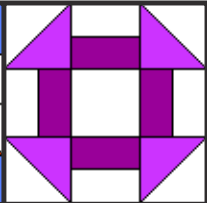

Paper Pieced Toucan

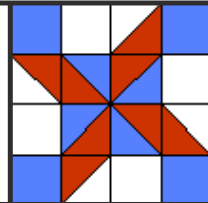
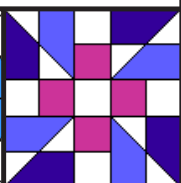
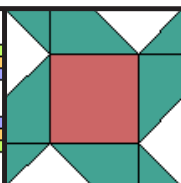
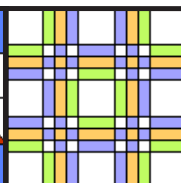
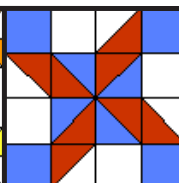
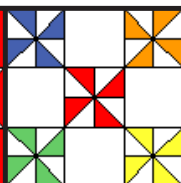
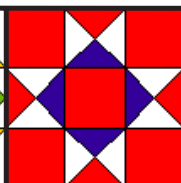
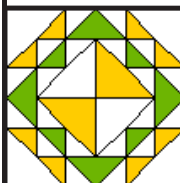

# Paper Pieced Toucan

This pattern will make a 6" x 8" toucan block. If you want to make it bigger, use a copy machine to "blow up" the pattern.

Print the two foundation pattern pages on whatever type of paper you like to use for paper piecing. I recommend something somewhat transparent, such as tracing paper or dressmaker's pattern paper. If your printer won't accept this type of paper, you can print it on regular paper and trace it onto the transparent paper.

Below is the color placement guide for the pattern.

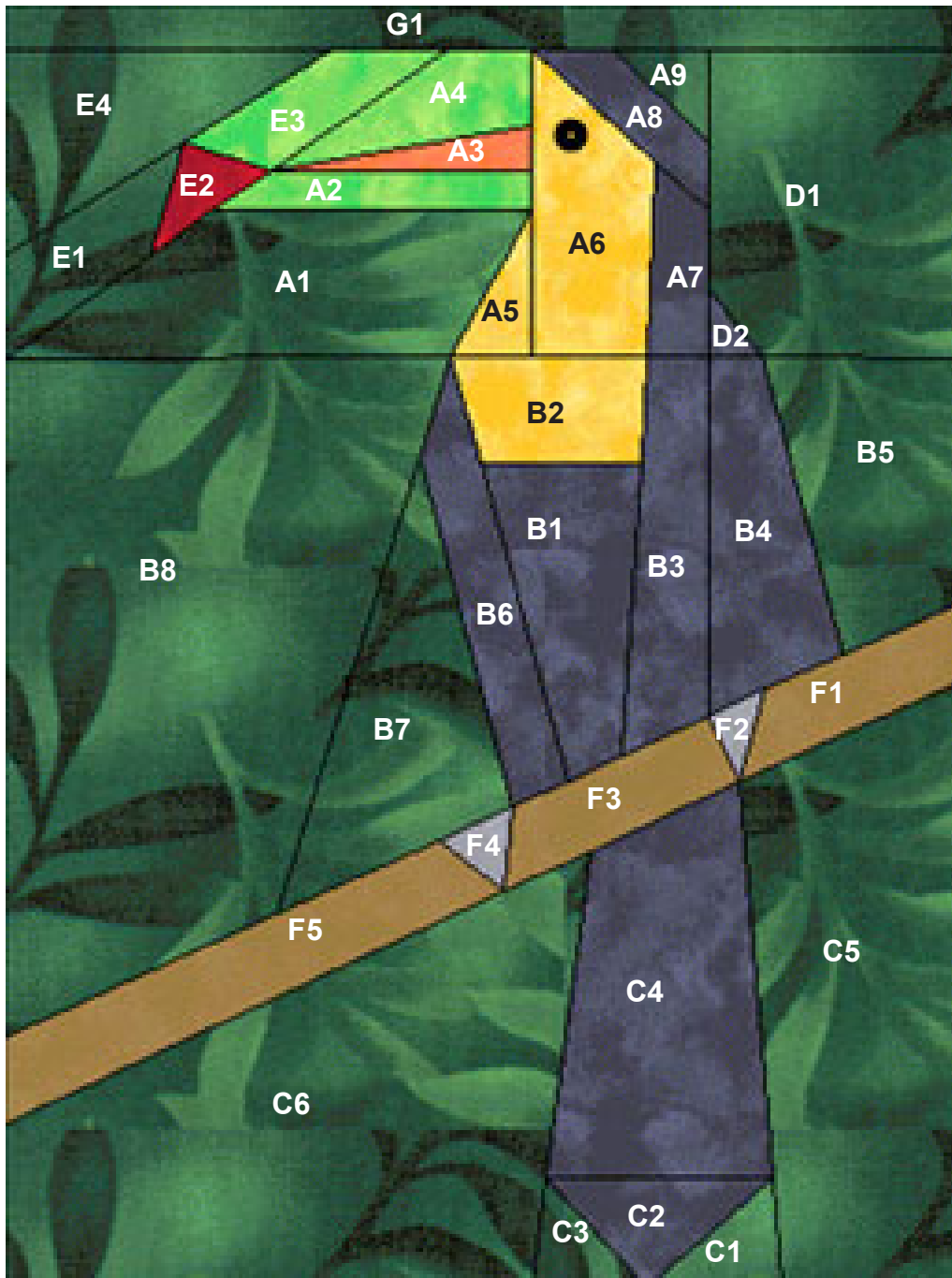

# Construction

1. Sew all of the sections separately.
2. Sew sections E and D onto section A.
3. Sew section G onto section A/E/D.
4. Sew section B onto section A/E/D.
5. Sew section F onto the bottom of section B.
6. Sew section C onto the bottom of section F.
7. Use a black button for the eye.

## Tips:

Most people like to keep the paper on until all the sections are sewn together, to keep the units stable. I prefer to take the paper off before sewing the sections together, but I always use spray sizing or spray starch on the units before sewing them together.

You can also use the freezer paper method of paper piecing, in which you don't have to tear any paper off, because you never sew through it. This method is outlined on my website at [www.quiltpox.davisfamilycreations.com/paper\\_piecing.htm](http://www.quiltpox.davisfamilycreations.com/paper_piecing.htm).

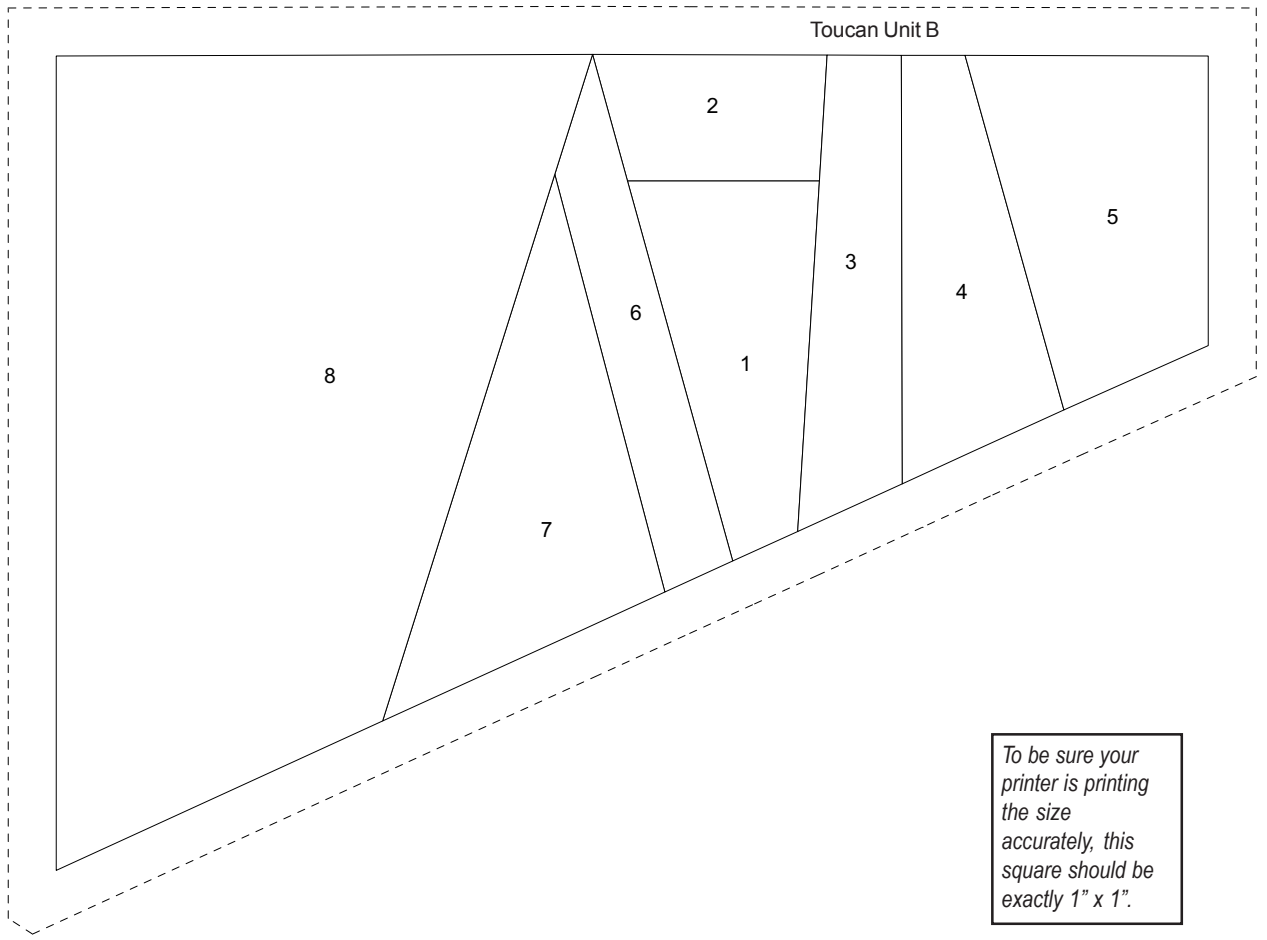
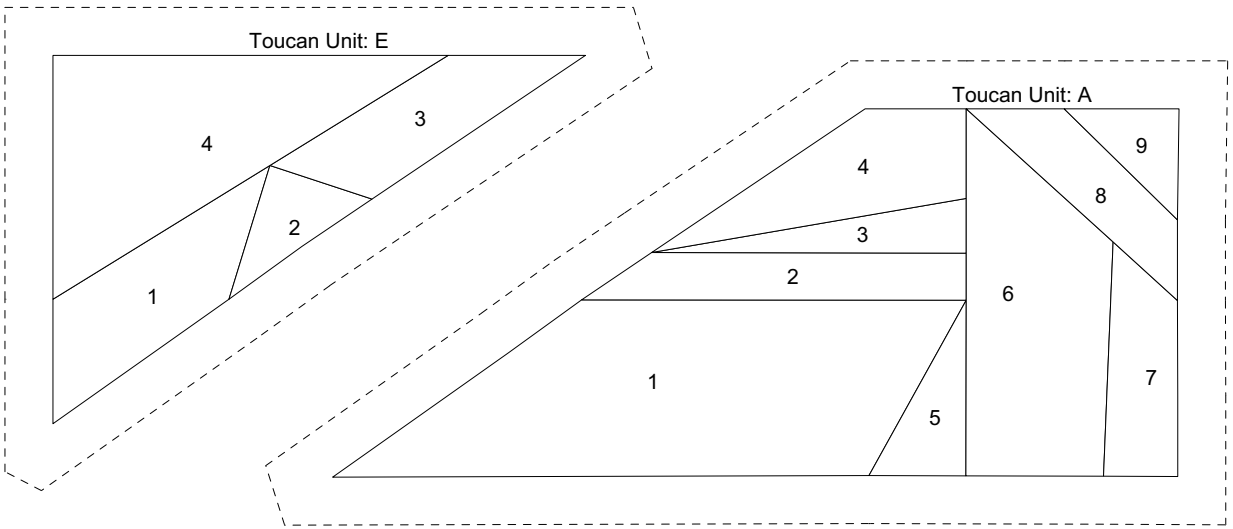
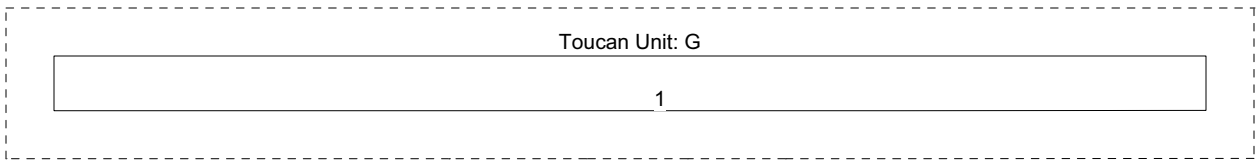

To be sure your printer is printing the size accurately, this square should be exactly 1" x 1".

To be sure your printer is printing the size accurately, this square should be exactly 1" x 1".

