

# rug bucket™



Made w/ a Target woven throw rug finished edges (no fringe), 31" X 19" ~\$7.00 retail



a free pattern from  
**StudioKat Designs**  
[www.studiokatdesigns.com](http://www.studiokatdesigns.com)

This design is copyrighted. Please do not copy or distribute without permission from StudioKat Designs.

Make this "easy as pie" tote bag in just a couple hours! Transform an ordinary lightweight woven throw rug into a really great gift for teachers, friends or YOURSELF!

## FABRIC & NOTIONS SUPPLIES

- One set of 20" handbag straps *with D-rings attached* **OR** 50 inches of 1" wide nylon webbing *plus four 1" D-rings*
- One 4" X 7" piece of each of the following for the Flap: imitation vinyl, fusible fleece & quilter's cotton
- One 3/4" magnetic snap
- 12 inches of double-fold bias tape (extra wide)



Made w/ a Home Depot basketweave rug Fringed ends, 40" X 20" ~\$3.00 retail

### A word about choosing & working with your woven rug-

A) It's easier to use a woven rug w/ either finished or turned under edges, (like the Target rug), as opposed to one w/fringed edges, (like the Home Depot rug). The Home Depot rug was a LOT harder to work with, because of the thickness of the basket-weaved fabric. My Necchi machine handled it pretty good, but I can promise you that my Singer would not have.

B) The finished size of your tote will depend entirely on the size of your rug & the gusset depth you choose. The deeper your gusset width, the shorter and wider your finished tote will be.

## sewing instructions

### flap closure

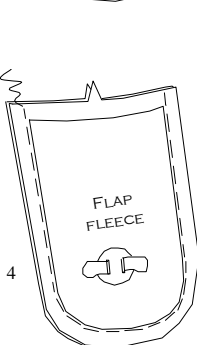
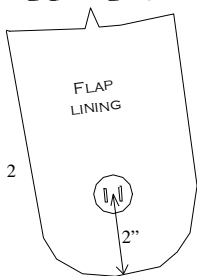

1) Center & fuse Flap Fleece to wrong side of Flap lining.

2) Center a mag snap **BACK** on right side of Flap lining, 2" above curved edge. Using metal snap-back as a guide, mark slit positions on lining with a pen. Carefully cut thru fabric at slit marks.

3) Separate the 2 sides of the mag snap. Push prongs of the "male" side thru slits to fleeced side of Flap. Place snap back over prongs & bend them to each side to secure mag snap in place.

4) Now place "snapped" Flap lining right sides together w/ Flap exterior, aligning raw edges & single notch. Stitch 1/4" from edges, leaving straight notched edge unstitched. Clip curves & trim seams to ~1/8". Turn Flap right side out & press flat. Topstitch 1/4" from finished edges.

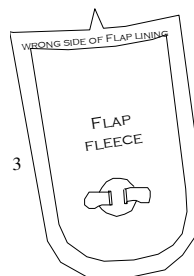

5) Center Flap right sides together, & 3/4" BELOW the short edge of your rug exterior. Stitch in place 1/4" from Flap notched edge.

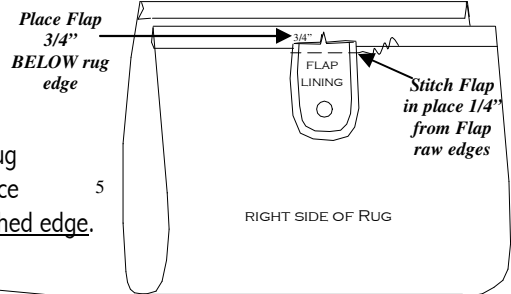
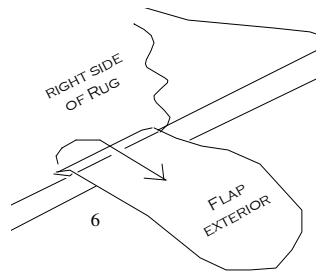

6) Press Flap UP & over rug edge. Stitch 1/4" from Flap pressed edge to conceal raw edges.

### attach straps

*If you have purchased handbag straps with D-rings, proceed to step 8.*

7) Cut webbing into two 22" lengths. Sear all 4 cut edges to prevent raveling. Loop each webbing end thru a D-ring. Zigzag webbing in place to secure it.

8) Cut four 6" pieces of extra-wide double fold bias tape. Press each one open, revealing inner folds of tape. Press over 1/2" (wrong sides together) at each end.

9) Now press each folded bias tape piece in half, then stitch close to all four edges to secure it all in place.

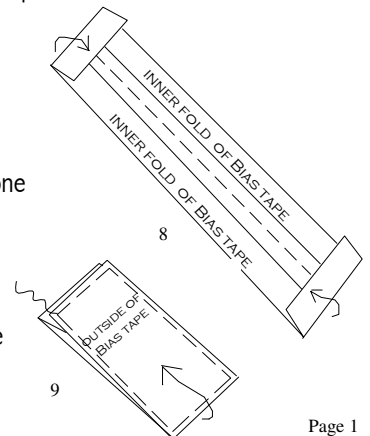

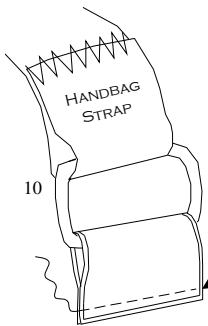

10) Loop a bias tape piece thru the D-ring of each Strap, folding bias tape in half. Baste edges to secure them.

*Baste bias tape edges together*

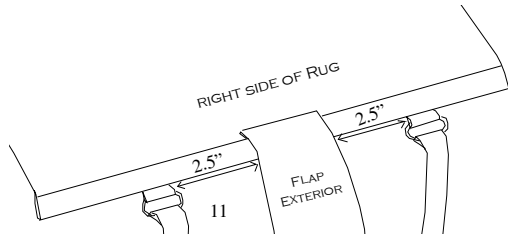

11) Place each set of bias tape edges along an **INSIDE** top edge of rug, ~2.5" from either Flap side edge. Pin these edges in place so that ~3/8" of each bias tape loop is visible above the edge of the rug.

12) When you're satisfied with the placement, stitch each set in place thru all layers of fabric. I recommend that you stitch more than one stitch line and that you liberally reinforce the stitching. (Remember, the entire weight of your tote bag will be concentrated on this stitching.)

*I recommend more than 1 line of stitching. Don't forget to reinforce the stitching!*

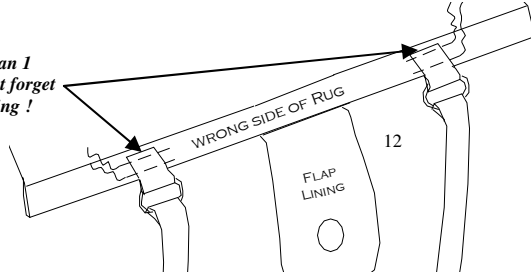

## let's put it all together now

13) Fold Rug **RIGHT** sides together now, aligning side edges & top corners. Stitch 1/2" from both sets of side edges. The layers are quite thick at this point, so stitch slow and steady for best results. Place pins at the bottom corners of what is now, the bottom edge of your bag.

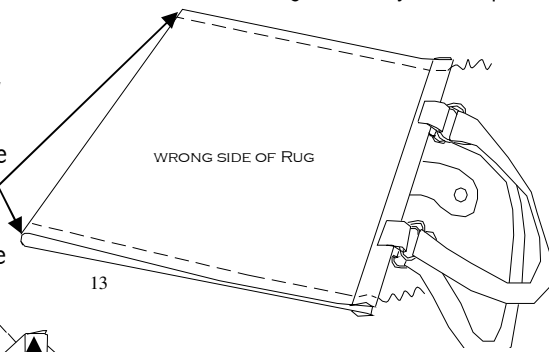

*Align each side seam w/pins from step 13.*

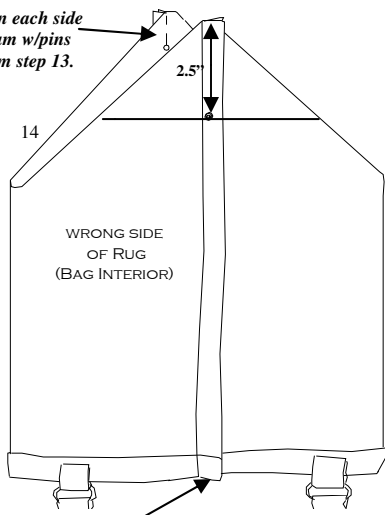

14) With right sides still together, fluff bag **OPEN**. Align each side seam with the pins along the bottom edge of bag, to form 2 triangular areas. (The side seams on each side should be in the **CENTER** of each triangular area.)

Mark a spot ~2.5" down from the peak of each triangle. Draw a straight line from this mark to the sides of both triangles.

**TOP of Bag**

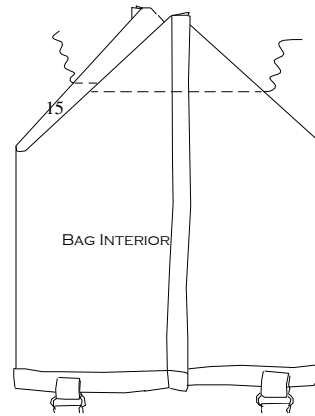

15) Stitch along both of these lines, thru both layers of the rug bottom, to form a gusset for your bag bottom. Reinforce stitching at both ends.

**Do NOT cut away fabric triangles!**

16) Turn entire bag right side out now, & fluff it open. Place Bag Flap as if closed on Bag Front to ascertain the positioning of the mag snap "female side". Mark this position & carefully cut 2 slits in Bag exterior.

Push mag snap prongs thru exterior to inside of Bag. Bend prongs over snap cover to finish.

## bag bottom support

17) Cut a piece of firm cardboard, 12" X 3.5" in size. Cover cardboard with a fabric sleeve made from lining fabric. (I suggest cutting your fabric 14" X 14" to make this sleeve.) Place the covered cardboard in the bag bottom (under fabric triangles), to keep your bag from sagging, no matter what you're carrying.

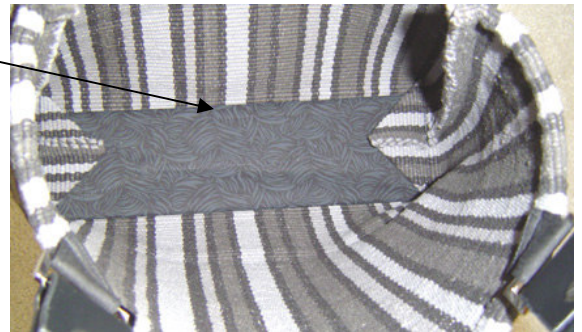

**You're DONE! Enjoy your RugBucket!**

## rug fringe tutorial

*There's two different ways to handle rug fringe. (Assuming of course that the rug does not exceed the thickness constraints of your machine, as mentioned in the opening paragraph.)*

A) Use it to your advantage! If the fringe is cool, turn it over to the **right side of your rug**, & stitch it in place there.

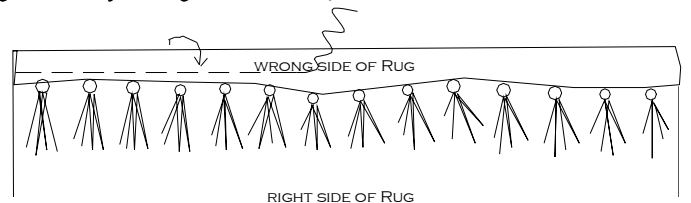

B) Get rid of it! You can zigzag stitch along the portion of the rug **BEHIND** the fringe to stabilize the area, then carefully trim the fringe away. Now flip the rug's cut edge of rug over to **the wrong side** & stitch it in place.

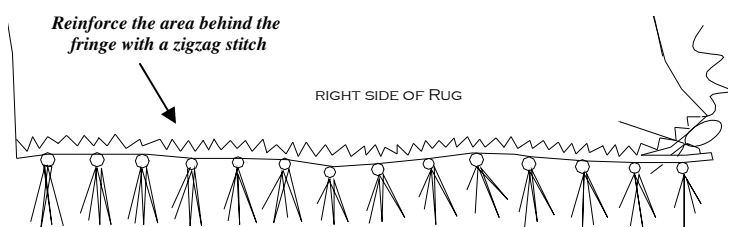

C) Now you can go ahead and use the rug to make your **RugBucket**.